

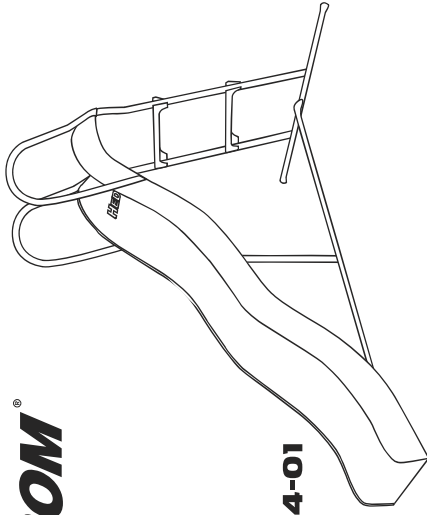

WAVY SLIDE - M08684-01

FOR CHILDREN AGED 3 TO 10 YEARS



SAFETY GUIDELINES

Warnings

Only for domestic use. This product has not been designed for commercial use in play centers, nurseries etc.

Only suitable for outdoor use.

Not for children under 3 years due to small component which may cause choking hazard.

This equipment must be assembled and checked by an adult. Two adults may be required to assemble this product. Adult supervision is required at all times.

Check all nuts, bolts and fittings for tightness and tighten if required.

Check all coverings for bolts and sharp edges and replace when required.

Check steps and slide for evidence of deterioration. Replace when required in accordance with the manufacturers instructions if necessary.

Place the product on level surface at least 2 metres from any structure or obstruction such as a fence, garage, house, wall, overhanging branches, laundry line or electrical wires.

DO NOT install the product over concrete, asphalt or any hard surface.

DO NOT orientate the product directly towards the sun.

Leave all fittings finger tight until assembly is complete, for ease of construction. Then tighten firmly.

Children should not wear cycle helmets whilst on this equipment.

Do not allow the children to get off the slide whilst in use.

Do not allow loose, hooded or baggy clothes to be worn as children can get trapped and may be unable to free themselves.

Do not allow children to climb on parts of this equipment not intended for this purpose.

Do not allow children to wander into the play area whilst the equipment is in use.

Do not allow children to slide head first down the chute, walk up the chute or jump or climb off the chute.

Regularly check the item for wear and damage, removing the item from use when necessary until replacement parts are fitted.

Failure to assemble and maintain this item as per instruction may cause injury to the user.

Do not modify this item.

Please keep the instructions in a safe place for future reference.

Conforms to EN71

Made in China to European Standards.

MV Sports & Leisure Ltd,
35 Tameside Drive
Cusle Bromwich
Birmingham B55 7AG
United Kingdom
email: info@mvsports.com
www.mvsports.com

CUSTOMER SERVICES
MV has taken great care to ensure that this toy has reached you in good condition. Should you have a query please contact customer.services@mvsports.com where your query will be dealt with promptly. Alternatively you can call on 0870 8404255.



The mark denotes compliance with the standards EN 71-1, EN 71-2, EN 71-3 and EN 71-4.
Name and address for future reference. If you wish to order the warranty, please contact the distributor at the address shown below.

SLIDE PARTS LIST



UPPER SUPPORT TUBE x 2



LOWER SUPPORT TUBE x 2



HANDLE x 2



STABILISER BAR x 1



LADDER TUBE x 2



VERTICAL SUPPORT TUBE x 1



FRONT TIE BAR x 1



REAR TIE BAR x 1



SUPPORT STRAP x 2



SUPPORT STRAP x 1



SUPPORT STRAP x 1

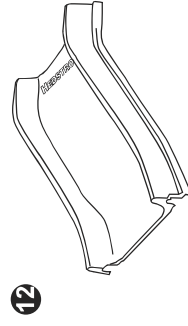

UPPER SLIDE x 1



LOWER SLIDE x 1



STEP x 2



CONNECTOR x 4



SPANNER x 1



ALLEN KEY x 1

IMPORTANT: Make sure you read the safety notice on the front page and always supervise children while they are playing on the equipment. Once assembly is completed carefully check equipment. In the unlikely event that you do find any problems, please contact us. Do not allow children to use this product until the problem has been corrected.

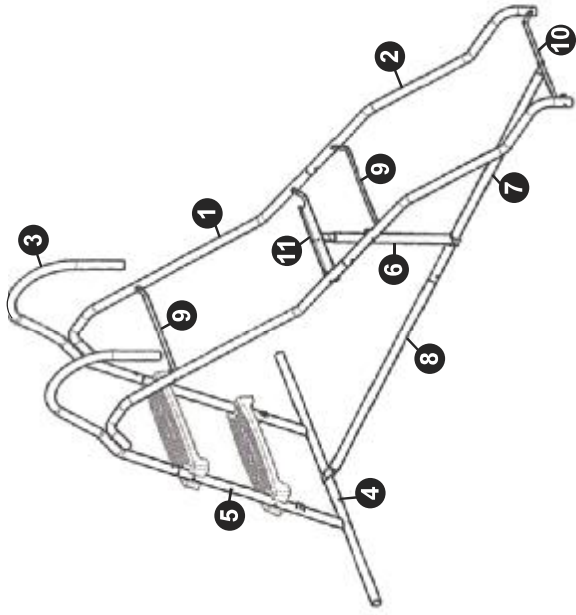

STEP 1
Slide Chute Assembly



M6 BOLT 20mm x 6 CONNECTOR x 4

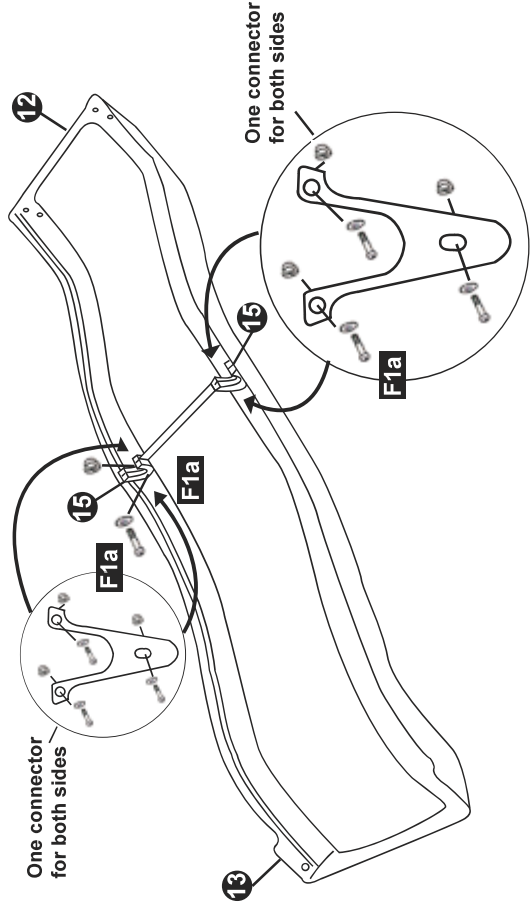

STEP 2
Bracket Assembly



M6 BOLT 17mm x 1



M6 BOLT 35mm x 8

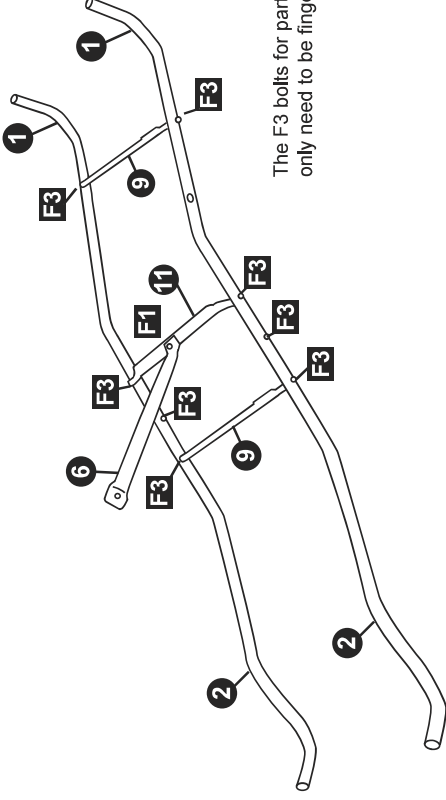

STEP 3
Assembly Of The Bracket Onto The Slide



M6 BOLT 17mm x 3



M6 BOLT 66mm x 2

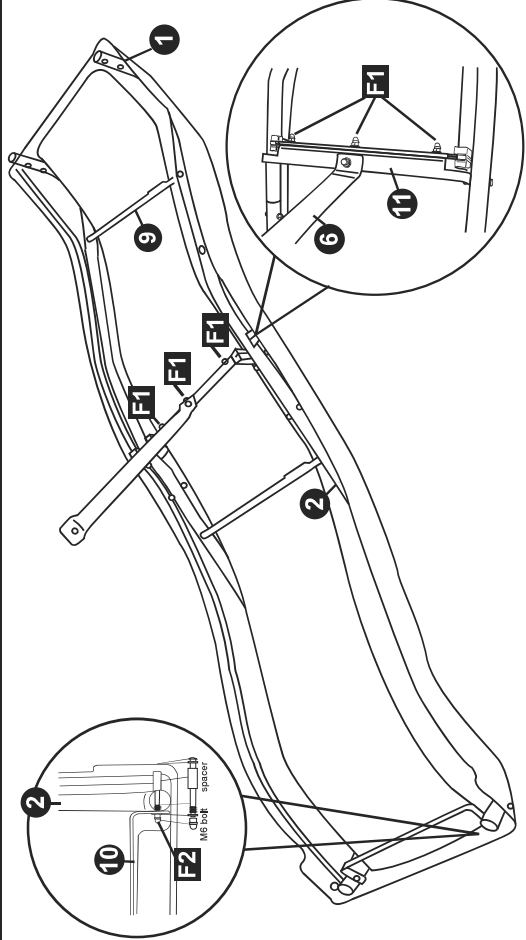

STEP 4
Tie Bar Assembly

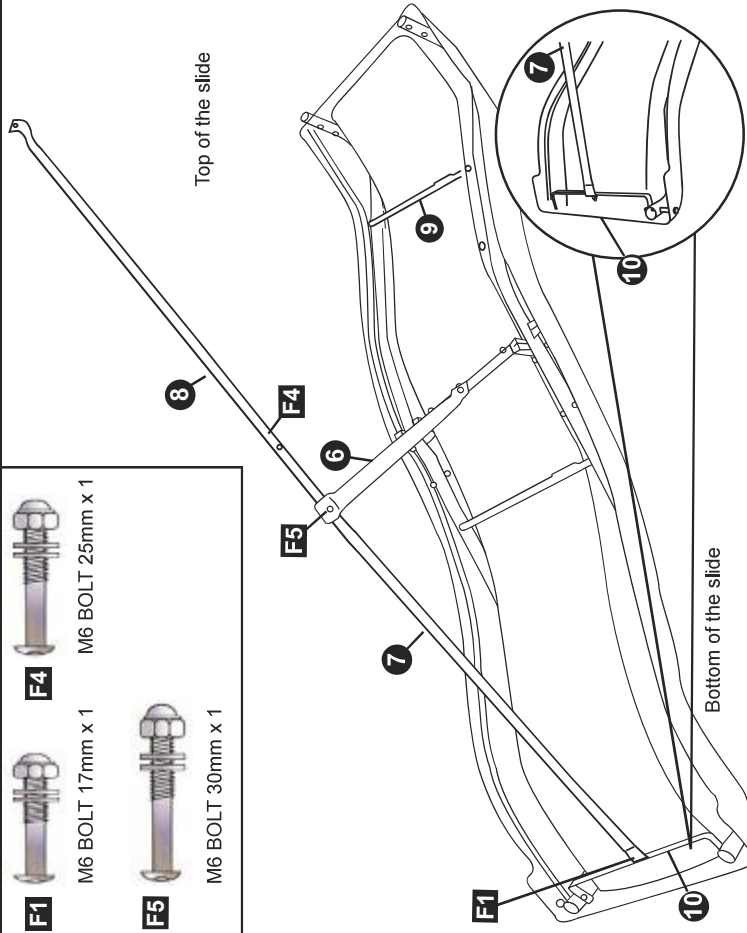
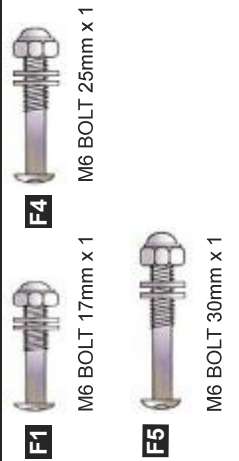

STEP 5
Ladder Assembly

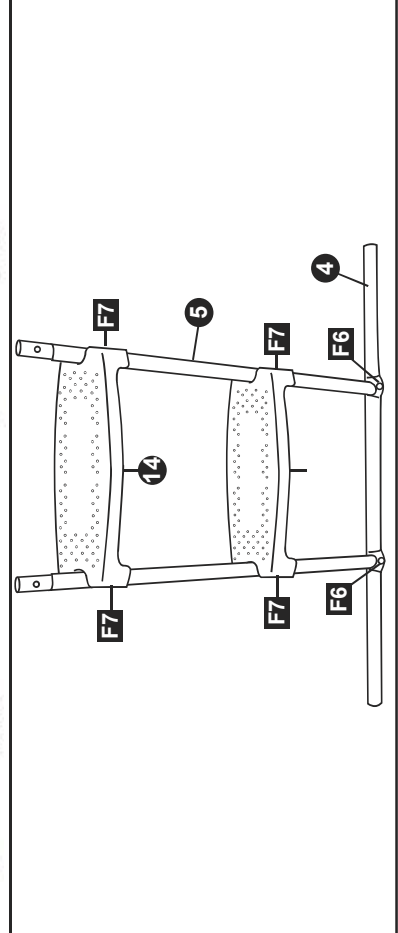

STEP 6
Assembling The Ladder To The Slide

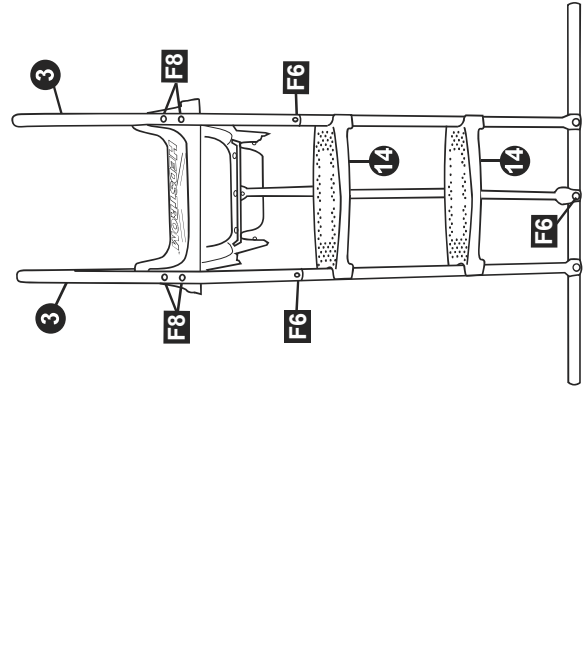
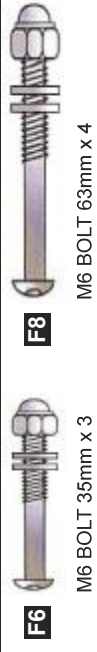

STEP 7
Assembly of the slide

